

Natural Ventilation Control

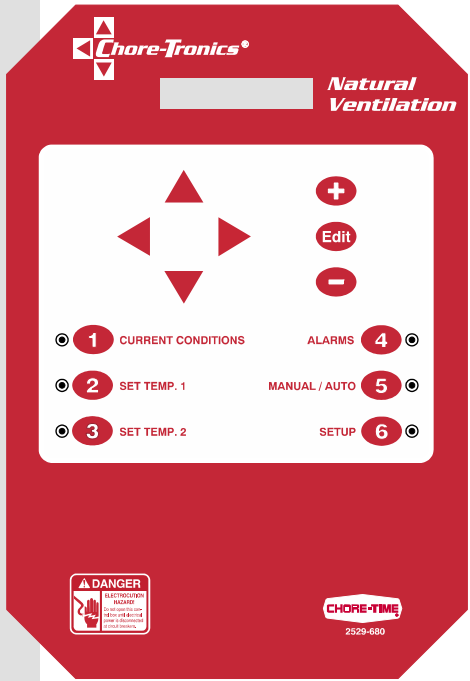

MT1558-01 7/88

User / Installer Manual

Limited Warranty

ICG, a division of CTB, Inc. ("Chore-Time") warrants the new CHORE-TRONICS[®] Natural Ventilation Control manufactured by Chore-Time to be free from defects in material or workmanship under normal usage and conditions, for One (1) year from the date of installation by the original purchaser ("Warranty"). If such a defect is determined by Chore-Time to exist within the applicable period, Chore-Time will, at its option, (a) repair the Product or Component Part free of charge, F.O.B. the factory of manufacture or (b) replace the Product or Component Part free of charge, F.O.B. the factory of manufacture. This Warranty is not transferable, and applies only to the original purchaser of the Product.

CONDITIONS AND LIMITATIONS

THIS WARRANTY CONSTITUTES CHORE-TIME'S ENTIRE AND SOLE WARRANTY AND CHORE-TIME EXPRESSLY DISCLAIMS ANY AND ALL OTHER WARRANTIES, INCLUDING, BUT NOT LIMITED TO, EXPRESS AND IMPLIED WARRANTIES, INCLUDING, WITHOUT LIMITATION, WARRANTIES AS TO MERCHANTABILITY OR FITNESS FOR PARTICULAR PURPOSES. CHORE-TIME shall not be liable for any direct, indirect, incidental, consequential or special damages which any purchaser may suffer or claim to suffer as a result of any defect in the Product. Consequential or Special Damages as used herein include, but are not limited to, lost or damaged products or goods, costs of transportation, lost sales, lost orders, lost income, increased overhead, labor and incidental costs, and operational inefficiencies. *Some jurisdictions prohibit limitations on implied warranties and/or the exclusion or limitation of such damages, so these limitations and exclusions may not apply to you. This warranty gives the original purchaser specific legal rights. You may also have other rights based upon your specific jurisdiction.*

Compliance with federal, state and local rules which apply to the location, installation and use of the Product are the responsibility of the original purchaser, and CHORE-TIME shall not be liable for any damages which may result from non-compliance with such rules.

The following circumstances shall render this Warranty void:

- Modifications made to the Product not specifically delineated in the Product manual.
- Product not installed and/or operated in accordance with the instructions published by the CHORE-TIME.
- All components of the Product are not original equipment supplied by CHORE-TIME.
- Product was not purchased from and/or installed by a CHORE-TIME authorized distributor or certified representative.
- Product experienced malfunction or failure resulting from misuse, abuse, mismanagement, negligence, alteration, accident, or lack of proper maintenance, or from lightning strikes, electrical power surges or interruption of electricity.
- Product experienced corrosion, material deterioration and/or equipment malfunction caused by or consistent with the application of chemicals, minerals, sediments or other foreign elements.
- Product was used for any purpose other than for the care of poultry and livestock.

The Warranty and Extended Warranty may only be modified in writing by an officer of CHORE-TIME. CHORE-TIME shall have no obligation or responsibility for any representations or warranties made by or on behalf of any distributor, dealer, agent or certified representative.

Effective: **April, 2014**

Instrument Controls Group
A division of CTB, Inc.
PO Box 2000
Milford, Indiana 46542-2000 USA
Phone (574) 658-4101 Fax (877) 730-8825
E-mail: www.choretimepoultry.com
Internet: poultry@choretime.com

Contents

Topic	Page
General	2
Chore - Time Warranty	2
Support Information	4
Distributor and Installer Information	4
Introduction	5
Explanation of Symbols and Special Manual Elements	5
Safety Instructions and Warnings	6
Notice to Electrician	7
Initial Setup	8
Introduction to Control	9
Description of Control Front Panel	9
Viewing Screen	10
Navigation Buttons	10
Edit Buttons	10
Subject Buttons	11
How to Maneuver in the Viewing Screen	12
Using the Navigation Buttons	12
Using the Edit Buttons	13
Relay Assignment	15
Actual House Layout	15
Operation and Description of Function Settings	16
Current Conditions Screen	16
Set Temperature 1	16
Set Temperature 2	16
Alarms	17
Manual / Auto	18
Setup	19
Technical Specifications	20
PC Connection Overview	21
Trouble Shooting	22
Wiring Diagram	23
Parts Listing	24

Support Information

Using this equipment for any other purpose or in a way not within the operating recommendations specified in this manual will void the warranty and may cause personal injury.

Distributor and Installer Information

Please fill in the following information about your Product.
Keep this manual in a clean, dry place for future reference.

Distributor's Name _____

Distributor's Address _____

Distributor's Phone _____ **Date of Purchase** _____

Installer's Name _____

Installer's Address _____

Installer's Phone _____ **Date of Installation** _____

System Specifications _____

Introduction

This manual is designed to provide comprehensive planning, installation, operation, and parts listing information. The Table of Contents provides a convenient overview of the information in this manual.

Read this manual before operating your Control.

If you have any questions regarding your Control, please contact your local Chore-Time dealer.

Explanation of Symbols and Special Manual Elements



<Caution>

Cautions alert you to potential damage to the Controller, if the procedures are not followed carefully.



! Danger !

Dangers alert you to potentially hazardous situations which, if not avoided could result in death or personal injury.

*** {Note}**

Notes contain additional information or “reminders” of important information you should know.

Safety Instructions and Warnings

- Read all instructions in this manual carefully, before operating the Control.
- Ground all electrical equipment for safety.
- The installation of the Control must be done by an authorized technician / installer
- All wiring should be done by a qualified electrician in accordance with local and national electrical codes.
- Electrical current to control must be hard wired into breaker box, eliminating any receptacle.
- Control should be located in an area that is protected from the elements.
- Front cover must be kept closed at all times except when front panel is in use.
- Control should be mounted securely to an internal wall or to a board that is mounted to a wall.
- It is recommended that an audible warning device (i.e. siren, phone dialer, etc.) be used to inform grower of unacceptable conditions.
- Check the Control regularly for possible malfunctioning. Notify your local Chore-Time distributor of any problems.
- It is recommended that the control be energized year round. This will help the interior of the control to stay dry, and extend the life of the memory backup battery. If the house is empty, use the manual switches to discontinue the function of equipment wired to the control.



<Caution>

- Check your Control regularly for proper functioning. This control is manufactured to provide reliable operation as well as an alert system to notify you of system failures. However, this cannot be 100% guaranteed because of circumstances that are beyond Chore-Time's control. Since this control is helping to provide a living environment for livestock, it is recommended that a Back-Up system be provided in the unlikely event of a system failure. Failing to provide a Back-Up will be viewed as the user's willingness to accept the risk of that loss.

- Chore-Time takes no responsibility for any possible damage as a result of improper settings and non or partially functioning installation.

- Chore-Time takes no responsibility for any possible damage due to failure, damage, or malfunction resulting from misuse, abuse, negligence, alteration, accident, lack of proper maintenance, improper or insufficient power sources or electrical connections, impact of foreign objects, tornado, hurricane, other violent storm, flood, fire, pollutants, chemicals, acts of God, or other causes outside the reasonable control of Chore-Time.



! Danger !

- Do not use running water or high pressure washers on or around your control.

Notice to Electrician

Each relay output in this Chore-Tronics[®] control is designed to control 1 H.P. for many years of service. The relays are single pole, normally open contacts and break only one line of the power to the various loads. (The control is not to be considered the disconnect device for motor loads.) If a load of more than 1 H.P. is controlled by a relay in the control, additional contactors are required and some of the basic flexibility of the control is compromised. It is very important that the owner/integrator understands that the grouping of loads compromises flexibility.

It is recommended that the installation diagram on **page 15** be used to configure the house. If this step is completed prior to wiring, it will eliminate any unnecessary confusion.

Initial Setup

1. Answer all questions and adjust all settings in *Screen #6*. In this screen the relay numbers are associated with the output names in the drawing on **page 15**. This must be done first in that the other screen's contents are affected by the answers and settings of *Screen #6*.
2. Answer all questions, and adjust settings in Screens # 2,3,4,5.
3. Recheck all screens to verify everything is as desired.



! Danger !

While going through the setup steps, place “Auto/Manual” in “Man” and in “Off” position until the process is completed.

*** {Note}**

Ignore alarms until setup process is completed. Then reset alarm system as described in *Alarms* section of this manual.

Introduction to Control

Description of Control Front Panel

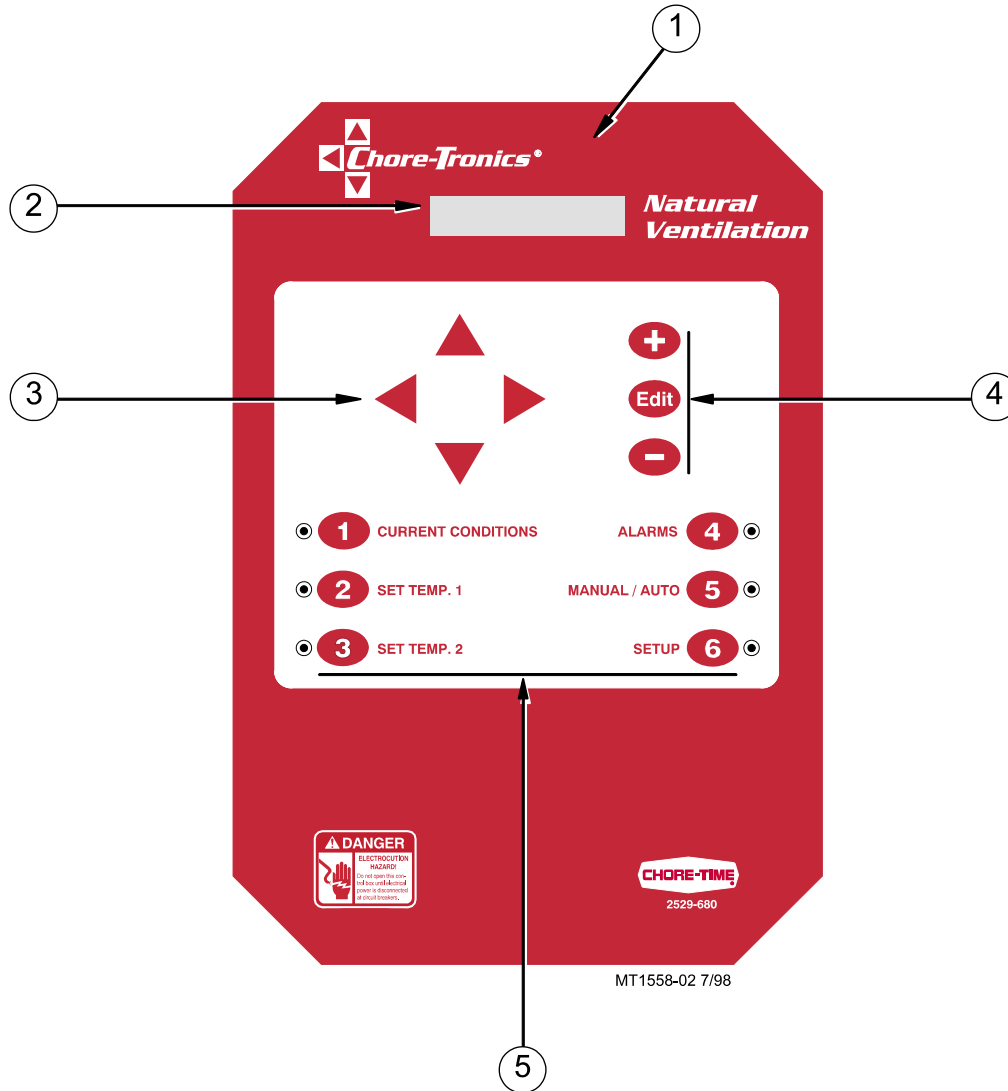

Item	Description
1	Natural Ventilation
2	Viewing Screen
3	Navigation Buttons
4	Edit Buttons
5	Subject Buttons

Viewing Screen

The viewing screen has a display which can show 1 line, containing 16 characters. This is the area that will display the requested information when a subject button is pressed. The viewing screen will always remain lit. When other subjects are not shown, the *Current Conditions* screen will be displayed

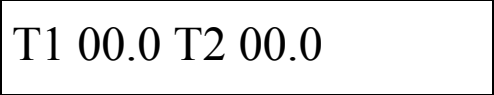

T1 00.0 T2 00.0

Navigation Buttons

These buttons allow you to scroll up and down in those few screens that have more information than will fit on the screen. When **HOLDING DOWN** an *up* or *down* arrow button, this will activate “fast forward”, which accelerates the scrolling process. The *left* and *right* arrows are used only when you are in the *Edit Mode* (explained below) and will move a cursor to an editable (changeable) position. This will highlight the area you want to change.

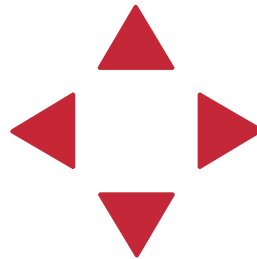

Edit Buttons

When the button labeled **EDIT** is pressed and you are looking at a screen that has editable fields, a cursor will appear. With the *Navigation Buttons*, you can move the cursor to the position on the screen you want to edit. By pressing the “+” or “-” button, it will change the numerical value up or down, or if you are changing text (i.e. “yes” or “no”) it will select the possible text choices. These buttons also have “fast forward” which will accelerate the changing of numbers.



* {Note}

An example of using the *Edit Buttons* and the *Navigation Buttons* are discussed later in this section.
See “How to Maneuver in the Viewing Screen”

Subject Buttons

On the front of the Controller are 6 subject keys each with an indicator light.

As each subject button is pressed, the subject that is described beside the button will appear on the screen and the light on the other side of the button will be lit. After viewing that subject for five minutes, and if no other buttons are pressed, the control will automatically return to *Current Conditions*.

An explanation of each subject is described in the following section entitled “**Operation**”.

How to Maneuver in the Viewing Screen

The procedures below give a brief overview on the use of the *Navigation Buttons* and the *Edit Buttons*.

For this example we will be looking at the *Setup* Screen. (*Button 6* on the Control front panel).

Using the Navigation Buttons

1. Press **BUTTON 6**.

Setup and Calibration screen for viewing appears (**Figure 1**).

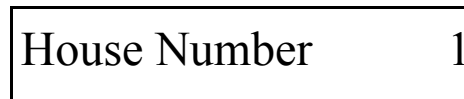

Figure 1. Setup Screen.

At this point you can move from line to line by pushing the **DOWN ARROW** or the **UP ARROW**. This will cause the text to either scroll up or down one line at a time.

2. Press the **DOWN ARROW** once.

The text will scroll one line (**Figure 2**). If you push the **UP ARROW** once the text will scroll back to the previous line.



Figure 2. Setup Screen.

* {Note}

The **LEFT** and **RIGHT** arrow keys are only functional in the *Edit Mode*.

See following page on the use of the *Edit Buttons*.

Using the Edit Buttons

This example gives you a brief summary on how to use the *Edit Buttons* in conjunction with the *Navigation Buttons* to edit values.

For this example we will be looking at the *Setup Screen*. (*BUTTON 6* on the Control front panel).

1. Press **BUTTON 6**.
Setup and Calibration screen for viewing appears (**Figure 3**).

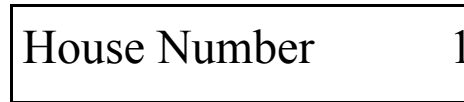

Figure 3. Setup Screen.

2. Press the **EDIT** button.
This activates the cursor and allows you to edit certain settings. **Figure 4** shows what the screen looks like.

- **Notice that the settings are highlighted when they can be edited.**

The white text with black background designates those areas that can be edited to the individual growers specifications. When viewing the actual Control Display, the text will be black with a shaded green background.

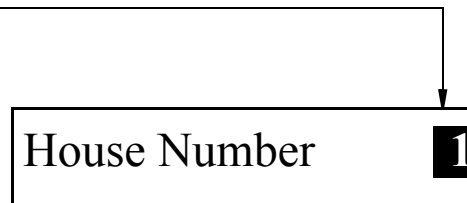

Figure 4. Setup edit Screen.

3. Press the (+) or (-) buttons to edit the House #.
The (+) key will increase the value and the (-) key will decrease the value.

4. Press the **DOWN ARROW** (Figure 5).



Figure 5. Setup edit Screen.

5. Press the (+) or (-) buttons to change from Fahrenheit to Celsius. In this case the (+) and (-) buttons select different text choices.
6. If two or more editable settings are on the same line, the *left* and *right* arrow buttons will be used to move between those positions.

* {Note}

To exit the *Edit Mode* — Press the EDIT key. This will take you out of the edit mode and turn off the cursor.

When a value or text is edited, it is immediately saved in the control. This eliminates the need for an enter key.

Relay Assignment

Actual House Layout

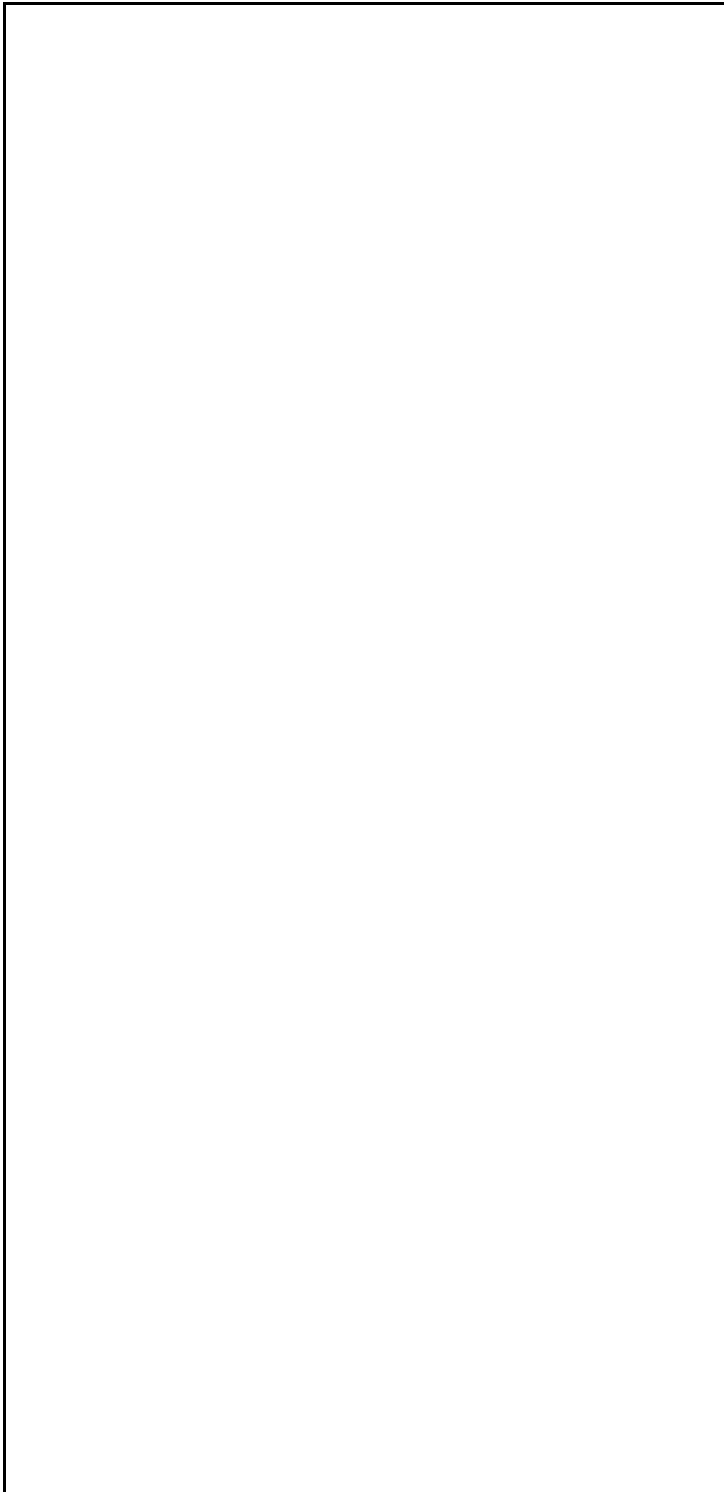

Relay

Device Controlled

- 1.
- 2.
- 3.
- 4.

Operation and Description of Function Settings

1

Current Conditions Screen

This unit is designed to control the operation of the side wall curtains in a natural only house. This is done by satisfying set temperature or temperatures if the optional second sensor is used.

Below shows the default screen and will always show as long as other subject buttons are not pressed.

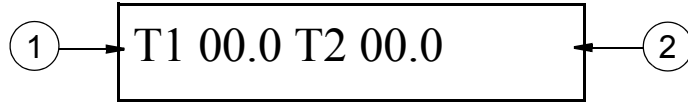

Figure 6. Current Conditions Screen.

1. Current temperature from sensor 1.
2. Current temperature from sensor 2 (optional).

2

Set Temperature 1



Figure 7. Set Temperature 1 Screen.

1. **Set Temperature 1** - this is the desired temperature that you chose to operate your house at. The control will do its best to maintain this temperature by operating the curtains accordingly. Maximum — 99.0°F (37.7°C), minimum — 40.°F (4.0°C).

3

Set Temperature 2



Figure 8. Set Temperature 2 Screen.

1. **Set Temperature 2** (optional) - same as *Set Temperature 1* **BUTTON 3**

4

Alarms



Figure 9. Alarms Screen.

* {Note}

The alarm output can be connected to external devices such as sirens or dialers. The control itself will present a visual display in this screen.

1. **Minimum 00** - this is where you indicate the minimum temperature alarm limit.
2. **Maximum 00** - this is where you indicate the maximum temperature alarm limit.

If you are in an alarm condition, the light next to the alarms button will flash.

By pressing button 4, you will be advised as to what the alarm condition is.

The alarm possibilities are as follows:

- Minimum temperature
- Maximum temperature
- Sensor failure
- Power failure

* {Note}

If the alarm message is a group of number's, the problem deals with the internal workings of the control and does not reflect problems within your house. If an alarm code appears in this space, notify your local distributor and advise him of the code.

5**Manual / Auto**

This screen allows you to override the control and operate the curtain manually.

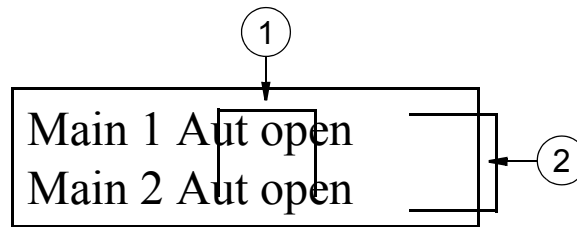

Figure 10. Manual / Auto Screen.

1. “**Aut**” - if this is showing, this indicates that the control is operating the equipment automatically.
2. To operate manually:
 - press the **EDIT** button
 - change “Aut” to “Man”
 - move the cursor to the right using the **RIGHT ARROW**
 - then press the “+” to open and the “-”to close

6

Setup

This is probably the most important screen in your control. This is the area that configures your control to meet the needs of your specific house management style. This setup should be done by a certified installer or distributor technician.

Figure 11.

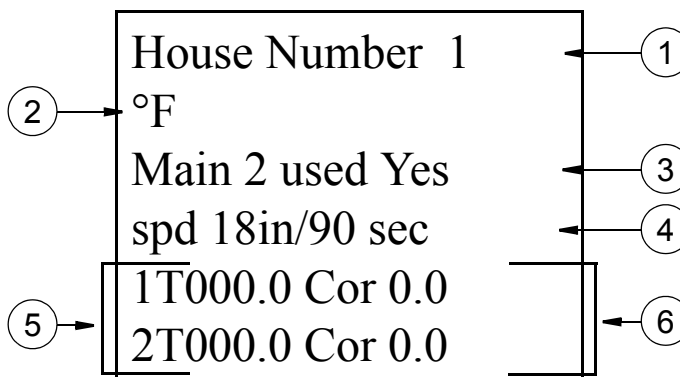

Figure 11. Setup Screen.

1. **House Number** - this is where you identify the house (barn) where the control is being setup. This is important when a PC is part of your system.
2. **Temperature Units** - Choose between Fahrenheit or Celsius temperature readings.
3. **Main 2 Used** - if you are operating your main curtains separately and using the optional second sensor, then answer yes. If your answer is no, then all references to the second sensor are removed.
4. **Curtain Speed** - here is where you tell the control the speed of the curtain operator. To do so, with the open switch, time how long it takes for the curtain to travel 18 inches. Insert this number by using the *Edit* buttons.
5. **Sensor Calibration** - sensors should not require calibration. You can define the readings if desired by using an accurate device to check the sensors. If you find that there is a discrepancy, simply insert the temperature your accurate device is reading.
6. This area is for troubleshooting purposes and is **not editable**.

Technical Specifications

Ambient Operating Temperature Range... -10°C to 50°C/14°F to 122°F

Set Temperature Range...4.4°C to 48.9°C/40°F to 120°

Supply Voltage.....200-240 Vac 50-60 Hz

Supply Current.....63 mA

Output Relays

Contacts.....SPST Normally Open contacts

Voltage.....250 Vac max

Load.....10 Full Load amps, 35 Locked Rotor / Start Amps
1000 W Incandescent Light Load @ 120 Vac

External Battery Input (To temporarily operate outputs manually)

Voltage.....24 Vdc

Load..... (.6) A max

Temperature Sensors:

NTC Thermister range: -30°C to 50°C/-22°F to 122°F; 10KΩ @ 77°F +/- .7°F

Sensor Wire.....20 gauge single twisted pair wire, 1 twist every 2 inches, unshielded wire. Use of Chore time part number 42208 strongly recommended.

FNET Data Voltage Range(C-Central).....+/-5 V

Alarm Relay

Voltage.....250 Vac 125 Vdc

Current.....8.0 A @ 250 Vac, 5.0 A @ 30 Vdc

PC Connection Overview

The Controls in each house are connected together at the FNET Terminal Connectors as shown below. Use only Twisted Pair Wire (Chore-Time Part No. 42208). The Interface Box can be wired in anywhere either at the beginning of your string, at the end, or between Controls; but not to more than one Control as shown in the **Figure 12.** below.

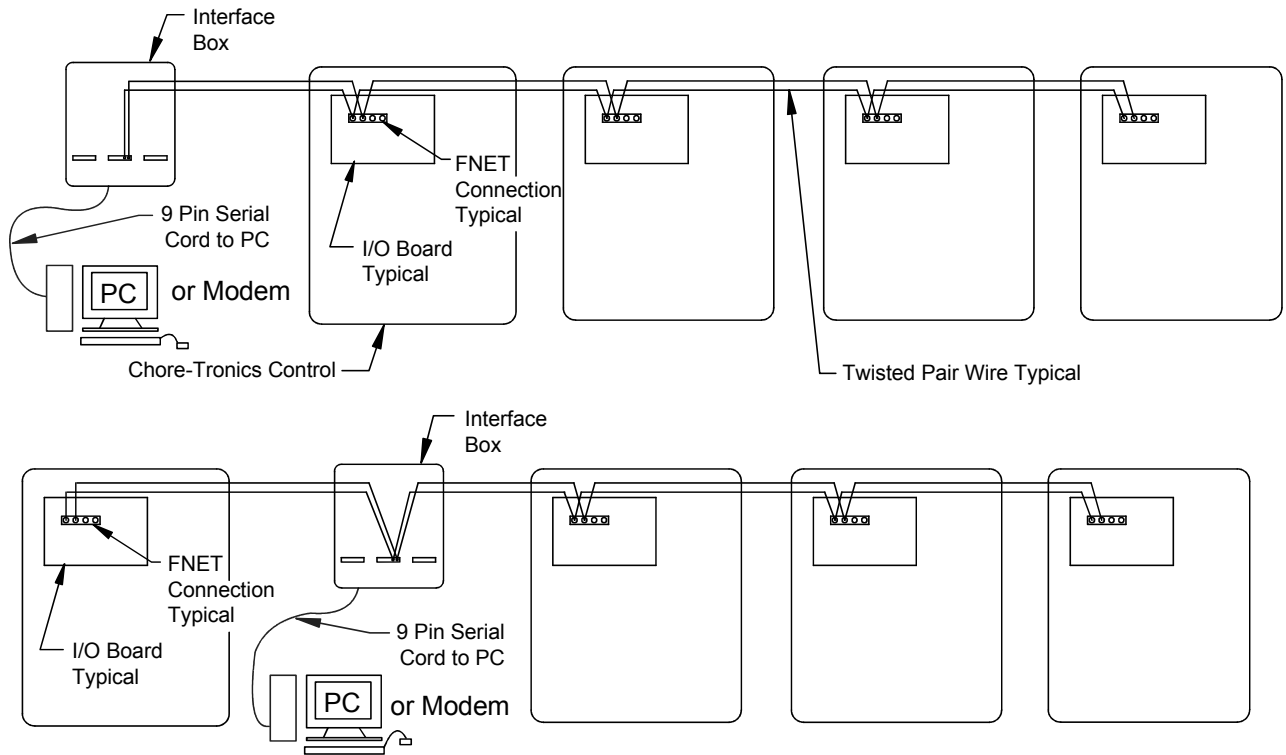

Incorrect Installation

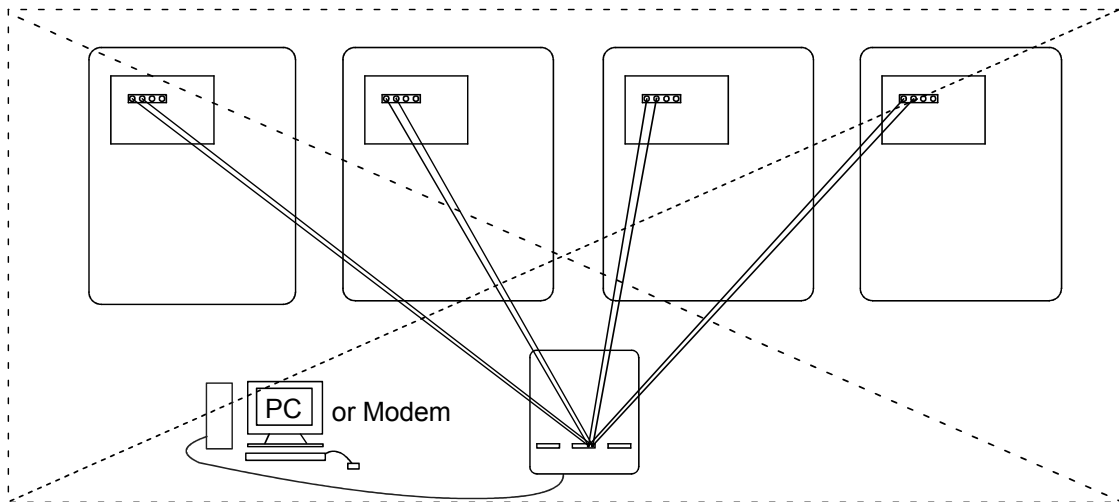

MT1701-059b 01/02

Figure 12. PC Connection Overview

Trouble Shooting

Problem	Possible Cause	Solution
The Screen is blank, but outputs appear to be operating normally.	The screen is defective.	Replace the display.
	The flat cable between the KD board and the screen is defective, loose or disconnected.	Readjust connections or replace cables.
The screen does not respond when pressing any of the Subject Buttons	The KD board is defective.	Replace the KD board.
An output does not work under any condition	The relay board is defective.	Replace the relay board.
The control seems completely dead — the screen shows nothing under any condition, and the indicator lights are off	The fuse for incoming power is blown.	Replace the fuse.
	The circuit breaker supplying power to the control is tripped.	Reset the breaker.
	The power supply or I/O board is bad.	Replace the power supply or I/O board.
	The KD board is defective.	Replace
	The flat cable from the power supply board to the IO board or IO board to the KD board is defective.	Readjust or replace.
Relays 1-4 are completely non-functional.	Relay board is defective or not connected properly.	Readjust or replace.
The failed temp. sensor or failed static pressure alarm is on, or the readings are clearly wrong.	Bad connections between the temperature sensor and the NV control's IO board.	Correct the bad connection.
	Defective or damaged sensor.	Replace
	Defective IO board.	Replace

Wiring Diagram

Natural Ventilation Control Wiring

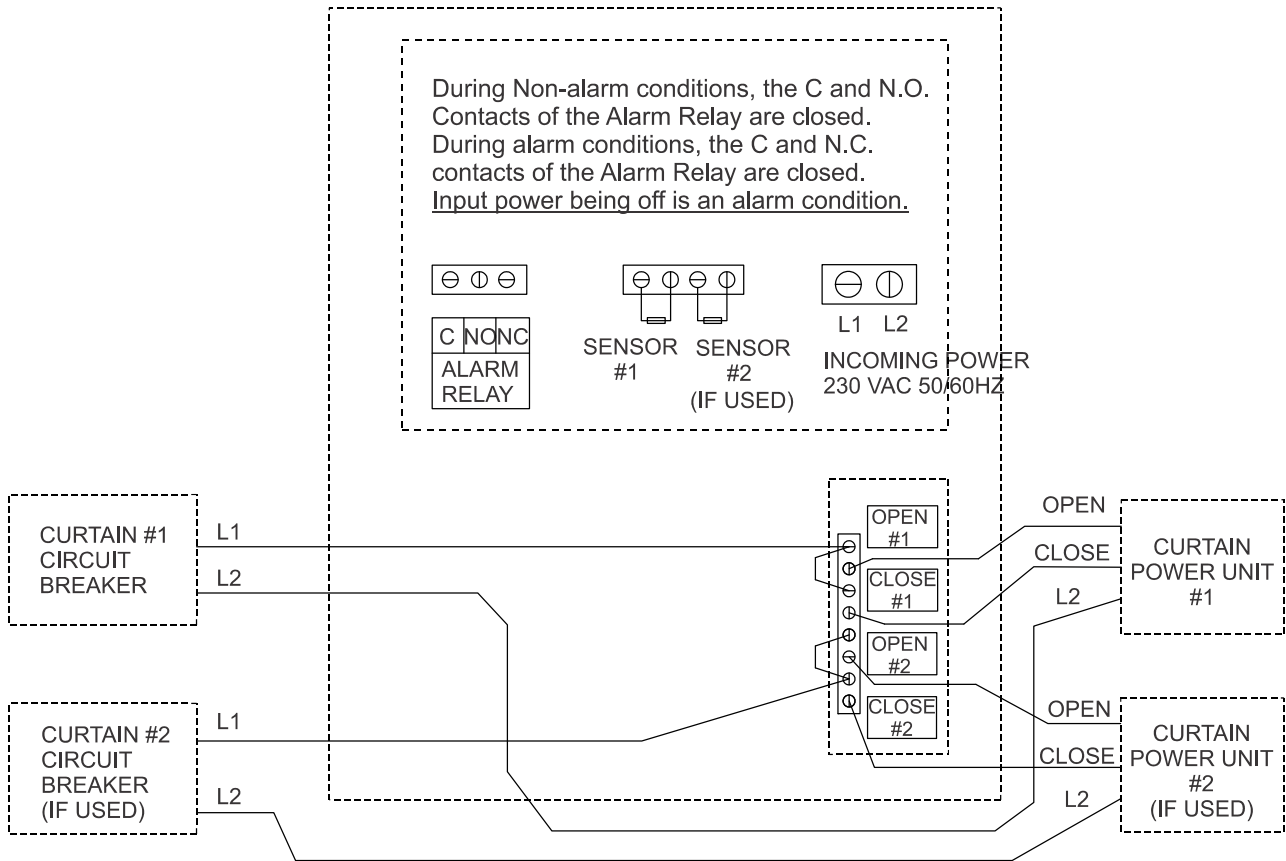

Parts Listing

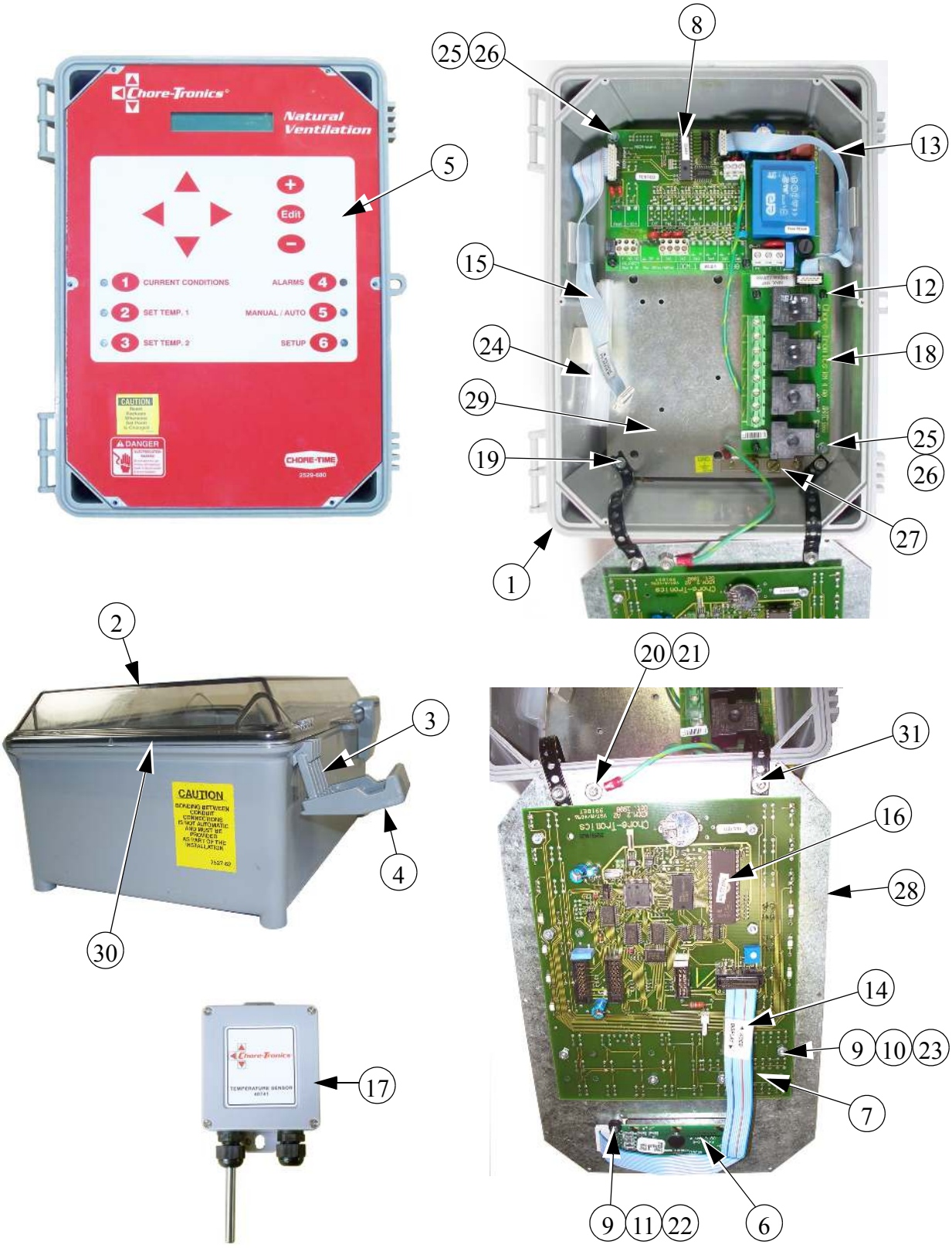

Item	Description	Part No.
1	Enclosure Body	30860-3
2	Enclosure Lid	30859-1
3	Pivot Hinge	30863
4	Pivot Latch	30862
5	Front Decal	2529-680
6	1 x 16 Display	41319
7	KDCM.2 Board	41316
8	IO.1 Board	41310
9	.05 Compressible Spacer	43381
10	KD Board Nylon Spacer	43382
11	Display Nylon Spacer	43383
12	.75 Nylon Standoff	42530
13	10 Pin 250mm Flat Cable	42510
14	16 Pin 210mm Flat Cable	41978
15	16 Pin 150mm Flat Cable	42239
16	NV Eprom Chip	42229
17	Temperature Sensor	40741
18	RM4 Board	41305
19	#8-18x.375 Self Tapping Screw	13019
20	External Lock Washer	305
21	#10-24 Hex Nut	8787
22	#2-56 Hex Nut	41972
23	#4-40 Hex Nut	3511
24	#4 x .25 SMS	28696
25	#8 x 1.25 Screw	43425
26	.75 Nylon Spacer	46103
27	Grounding Rail	43384-1
28	Top Plate	41649
29	Bottom Plate	41328
30	Neoprene Seal	34767
31	Black Strap	29014-4



Revisions to this Manual

Page No.	Description of Change
Various	Added Wiring Diagram and Tech Specs. Updated Parts Pages

Contact your nearby Chore-Time distributor or representative for additional parts and information.

Chore-Time Group
A division of CTB, Inc.
PO Box 2000
Milford, Indiana 46542-2000 USA
Phone (574) 658-4101 Fax (877) 730-8825
E-mail: www.choretimepoultry.com
Internet: poultry@choretime.com